

Data Sheet



Article number: 021816011135

Description: Clamp with bracket and rubber
SPGU 6011. 135/30 SK

Measures

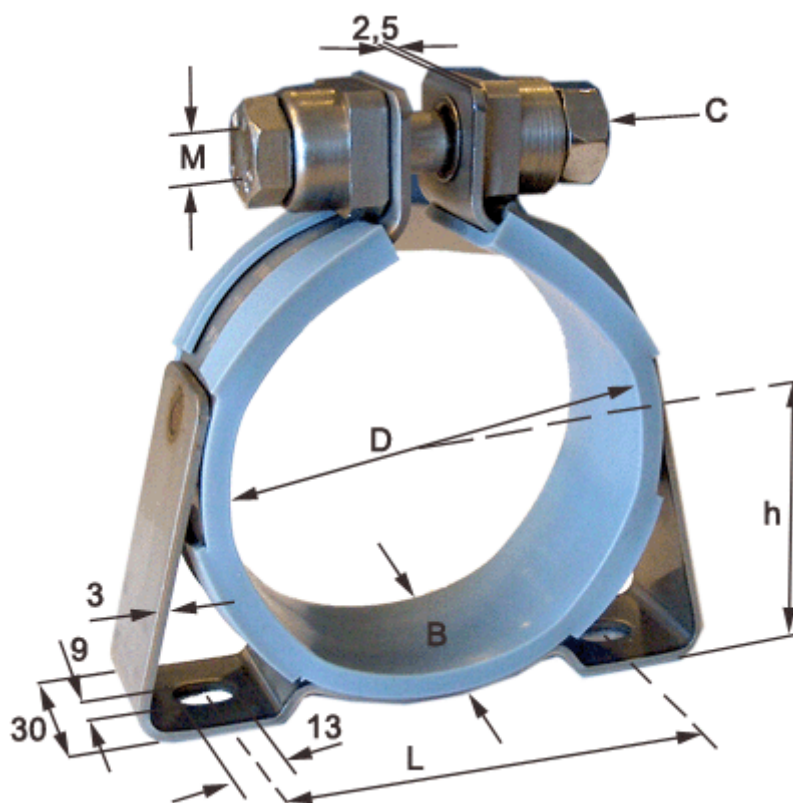

C (screw type) = SK hexagon screw

Diameter D = 135

h = 76

L = 136

Width B = 30